



GENERATOR TYPE ECO 43-1SN/4

Document : **DS027A/1**
issue 010 date 01/06/2011

Electrical Characteristics										
Frequency	Hz	50				60				
Voltage (parallel star)	V	380	400	415	440	415	440	460	480	
Rated power class H	kVA	800	800	800	690	880	960	960	960	
	kW	640	640	640	552	704	768	768	768	
Rated power class F	kVA	730	730	730	610	800	870	870	870	
	kW	584	584	584	488	640	696	696	696	
Regulation with	DSR	±1% with any power factor and speed variations between -5% +30%								
Insulation class		H								
Execution		Brushless								
Stator winding		12 ends								
Rotor		with damping cage								
Efficiencies class H	4/4	%	95,2	95,1	94,9	94,7	94,7	95,2	95,4	95,3
(see graph. for details)	3/4	%	95,6	95,3	95,4	95,2	95,3	95,5	95,9	95,6
	2/4	%	94	93,9	93,9	93,3	94,2	94,3	94,5	94,4
	1/4	%	92	92	91,8	90,8	92,9	93	93	93
Reactances (f. l.c.l. F)										
	Xd	%	391,1	353	327,9	243,8	434,2	420,1	384,4	353
	Xd'	%	21,3	19,2	17,8	13,3	23,6	22,8	20,9	19,2
	Xd''	%	11,0	9,9	9,2	6,8	12,2	11,8	10,8	9,9
	Xq	%	167,3	151	140,3	104,3	185,8	179,7	164,4	151
	Xq'	%	167,3	151	140,3	104,3	185,8	179,7	164,4	151
	Xq''	%	23,5	21,2	19,7	14,6	26,1	25,2	23,1	21,2
	X ₂	%	17,3	15,6	14,5	10,8	19,2	18,6	17,0	15,6
	X ₀	%	3,7	3,3	3,1	2,3	4,1	3,9	3,6	3,3
Short Circuit Ratio	Kcc		0,45	0,50	0,55	0,65	0,36	0,40	0,45	0,50
Time Constants	Td'	sec.	0,225							
	Td''	sec.	0,0182							
	Tdo'	sec.	7,70							
	Tα	sec.	0,0202							
Short Circuit Current Capacity		%	>300				>350			
Excitation at no load	Amp.		1,7	2	2,3	2,8	1,1	1,4	1,6	1,8
Excitation at full load	Amp.		4,3	4,8	5	4,8	3,8	4	4,3	4,5
Overload (long-term)		%	1 hour in a 6 hours period 110% rated load							
Overload per 20 sec.		%	300							
Stator Winding Resistance (20°C)	Ω		0,0109							
Rotor Winding Resistance (20°C)	Ω		2,1							
Exciter Resistance (20 °C)	Ω		Rotor : 0,130				Stator : 10,63			
Heat dissipation at f.l.c.l.H	W		32269	32976	34394	30893	39400	38723	37031	37876
Telephone Interference			THF < 2%				TIF < 40			
Radio interference			EN61000-6-3, EN61000-6-1. For others standards apply to factory							
Waveform Distors.(THD) at f. load	LL/LN %		2,8 / 2,6							
Waveform Distors.(THD) at no load	LL/LN %		3,1 / 3,0							
Mechanical characteristics										
Protection			IP 21 (other protection on request)							
DE bearing			6324							
NDE bearing			6322							
Weight of wound stator assembly	kg		624							
Weight of wound rotor assembly	kg		478							
Weight of complete generator	kg		1870							
Maximun overspeed	rpm		2250							
Unbalanced magnetic pull at f.l.c.l.F	kN/mm		5							
Cooling air requirement	m³/min		90				108			
Inertia Constant (H)	sec.		0,261				0,314			
Noise level at 1m/7m	dB(A)		95 / 84				99 / 89			

All technical data are to be considered as a reference and they can be modified without any notice.

This document is a propriety of Mecc Alte S.p.A.. All rights reserved.

50 Hz

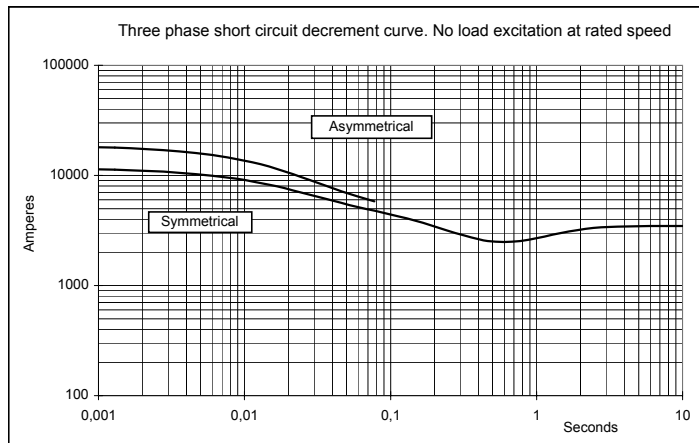
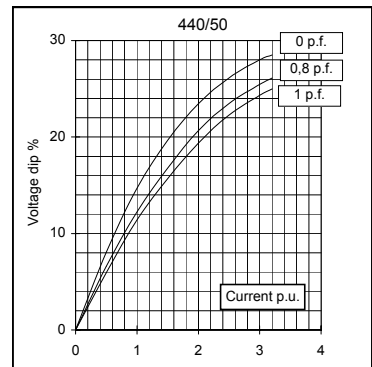
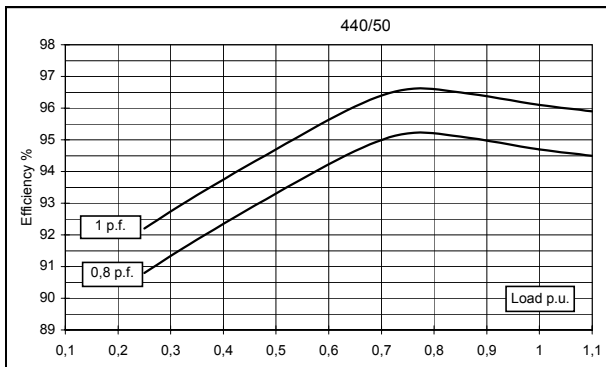
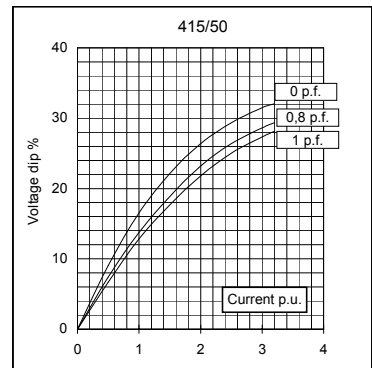
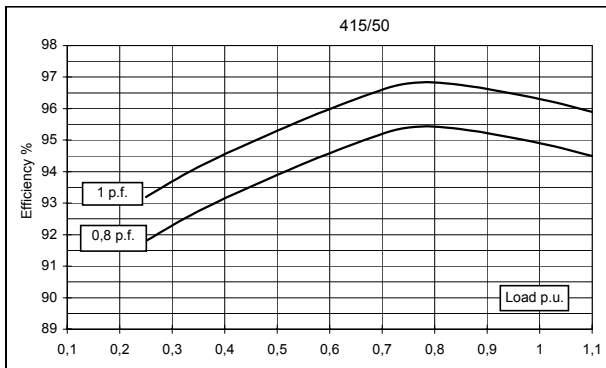
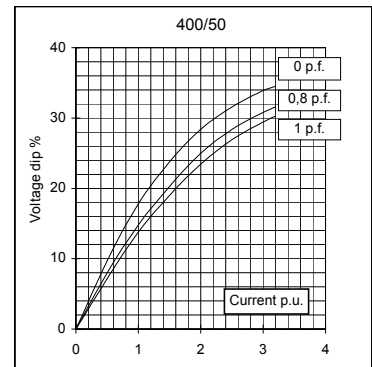
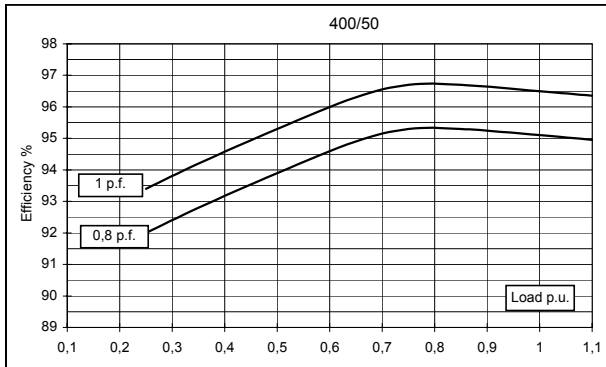
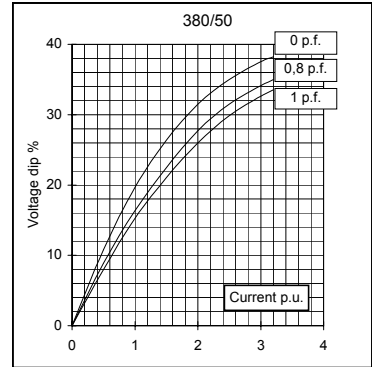
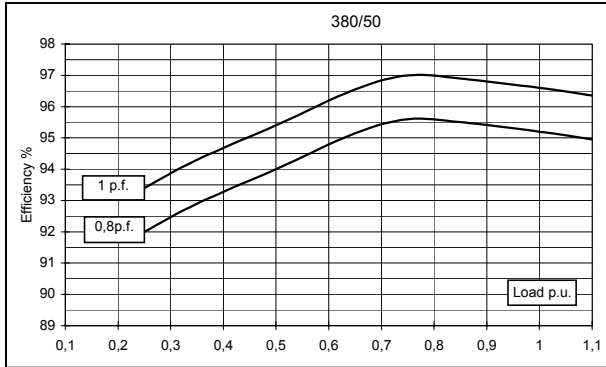

60 Hz

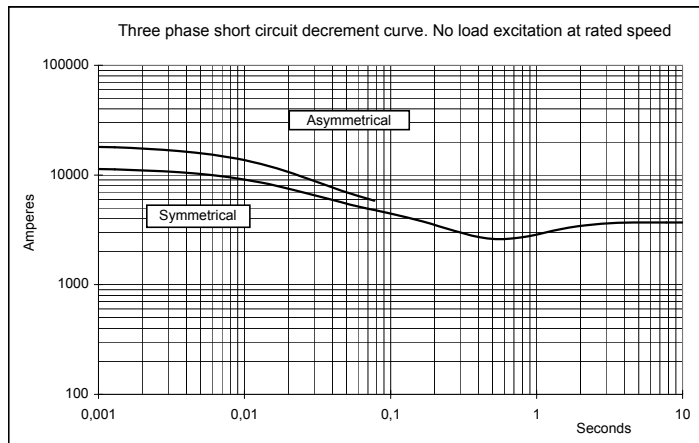
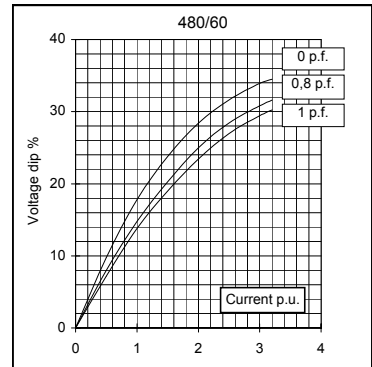
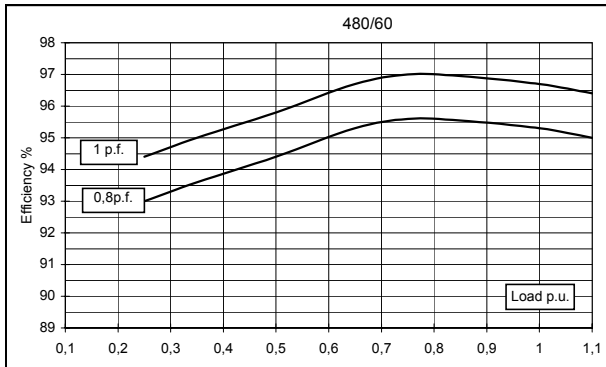
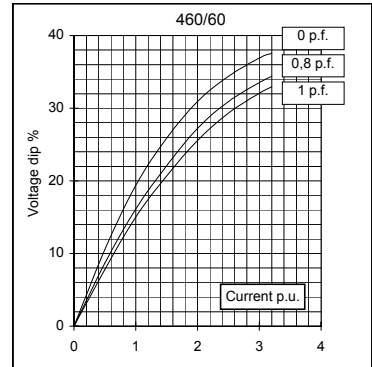
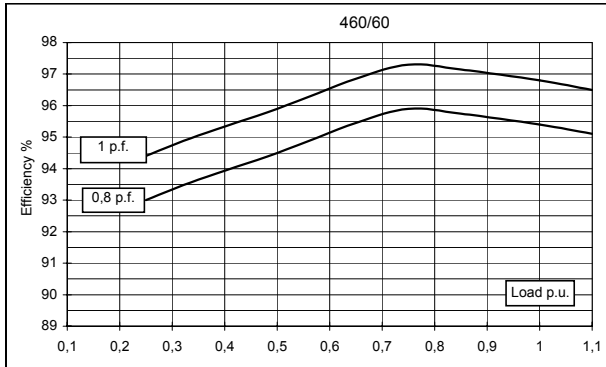
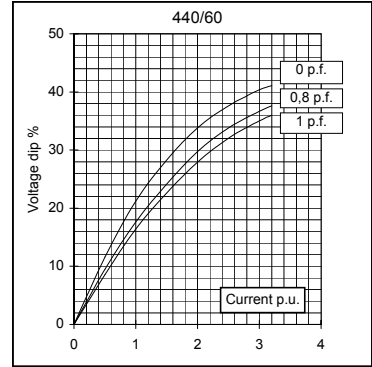
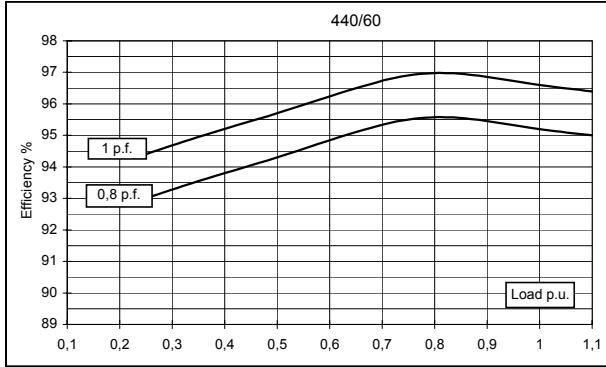
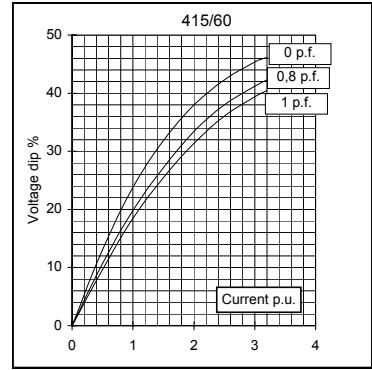
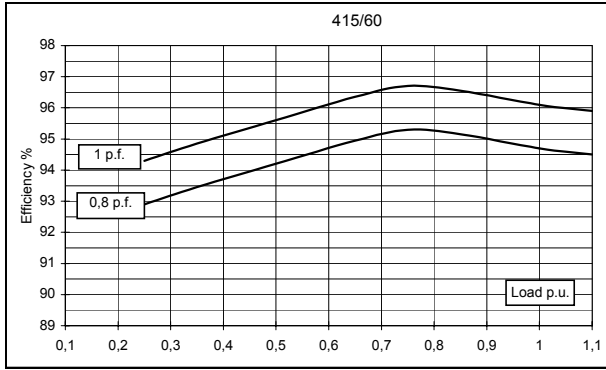

TWO BEARING MOMENTS OF INERTIA

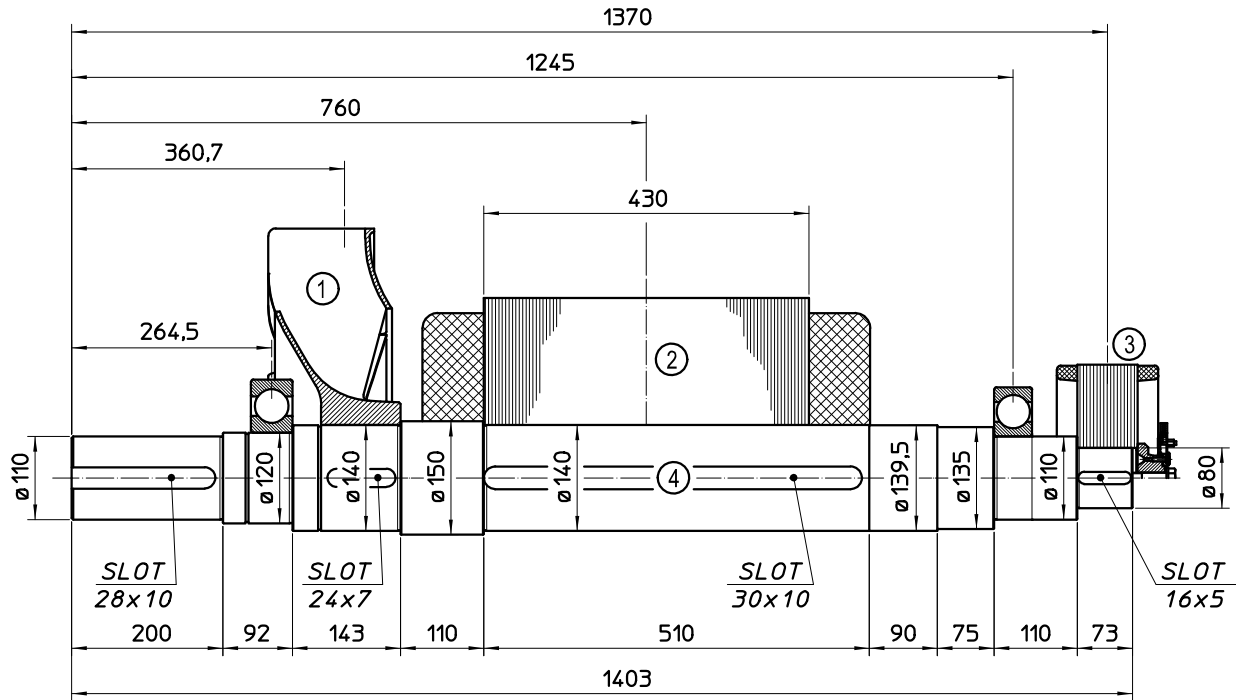

POS.	COMPONENT	WEIGHT (kg)	J (kgm ²)
1	FAN	16.3	0.646
2	MAIN ROTOR	478	15.318
3	EX. ROTOR	40	0.629
4	SHAFT	147.1	0.426
TOTAL		681.4	17.019

TWO BEARING DIMENSIONS

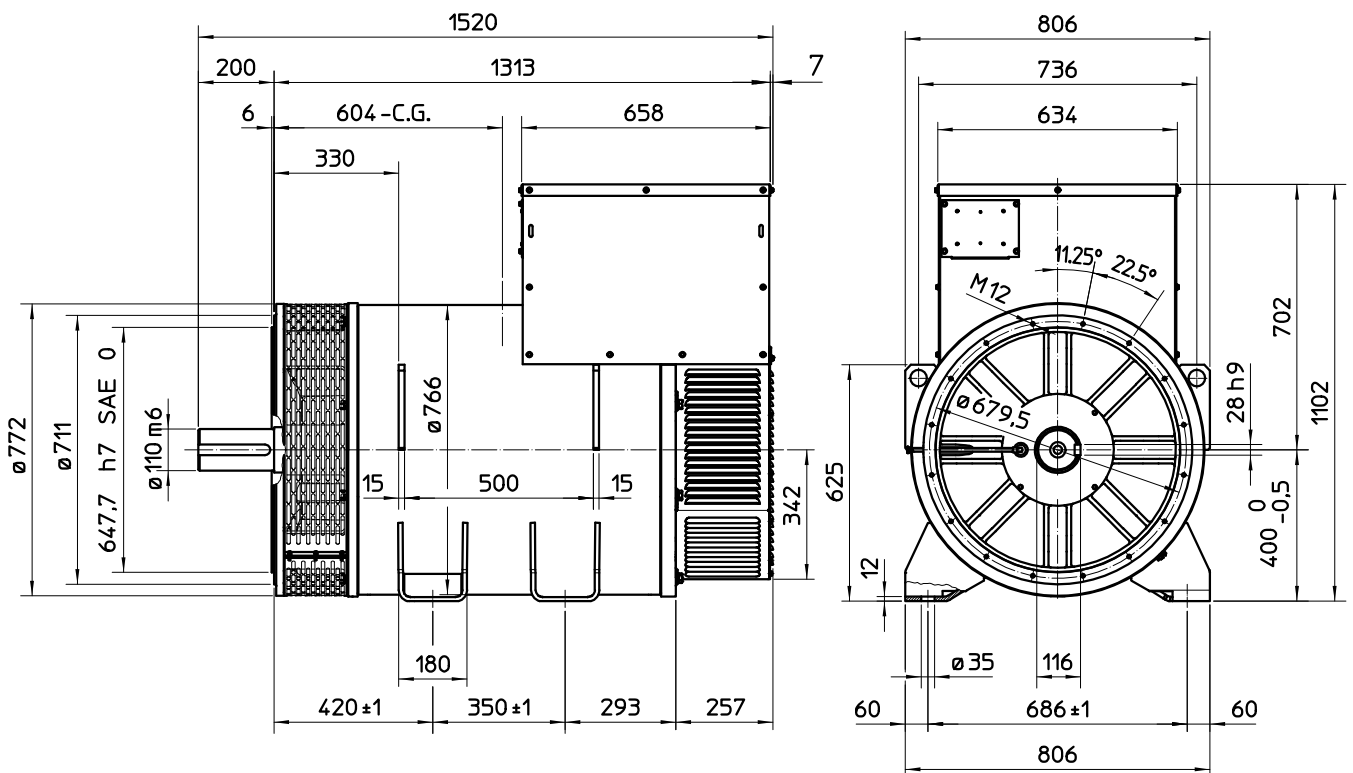

C.G.= GRAVITY CENTER

SINGLE BEARING MOMENTS OF INERTIA

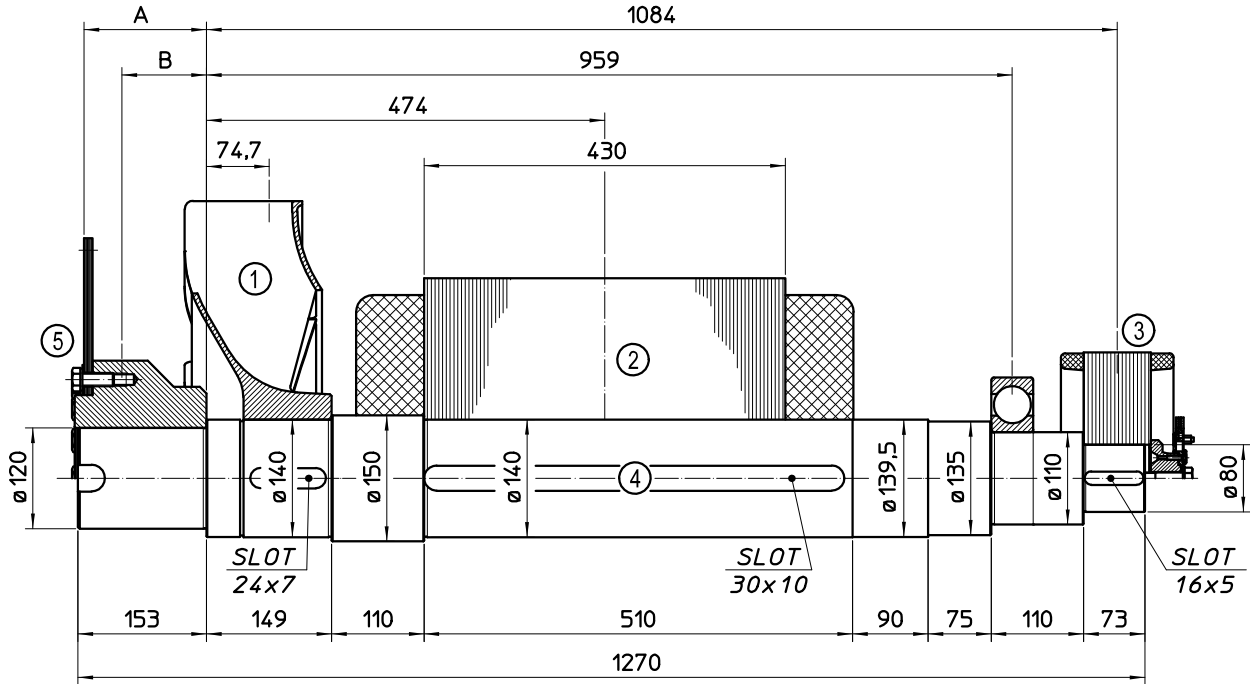

POS.	COMPONENT	WEIGHT (kg)	J (kgm ²)
1	FAN	16.3	0.646
2	MAIN ROTOR	478	15.318
3	EX. ROTOR	40	0.629
4	SHAFT	136	0.314
TOTAL		670.3	16.907

POS.	COMPONENT	SAE N°	A	B	WEIGHT (kg)	J (kgm ²)
5	SHAFTS COUPLING FLEX PLATE	14	155.7	99.5	56.3	0.824
		18	145.7	100.7	60.8	1.244
		21	130	98.5	68.9	2.231

SINGLE BEARING DIMENSIONS

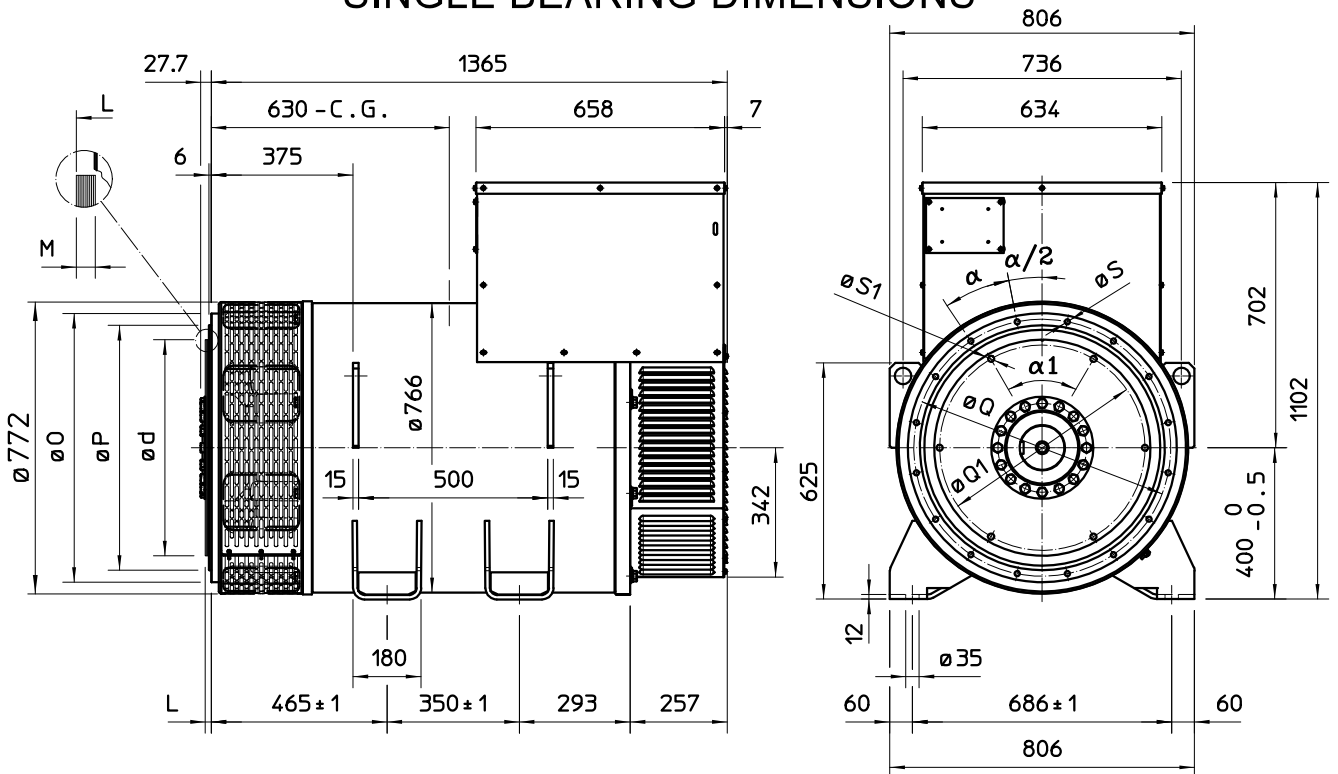

SAE N°	FLANGE					
	O	P	Q	S	HOLES N°	α
1	711	511.2	530.2	12	12	30
0	711	647.7	679.5	14	16	22.5
00	883	787.4	850.9	14	16	22.5

SAE N°	DISC COUPLING						
	d	L	M	Q1	S1	HOLES N°	$\alpha 1$
14	466.72	25.4	10	438.15	13.5	8	45
18	571.5	15.7	10	542.92	16.5	6	60°
21	673.1	0	12	641.35	16.5	12	30°

C.G.= GRAVITY CENTER