



GENERATOR TYPE ECP 3-1S/4

Document : DS148A/1

issue 002 date 29/04/2014

Electrical Characteristics										
Frequency	Hz	50				60				
Voltage (series star)	V	380	400	415	440	415	440	460	480	
Rated power class H	kVA	6,5	6,5	6,5	5,5	7	7,8	7,8	7,8	
	kW	5,2	5,2	5,2	4,4	5,6	6,2	6,2	6,2	
Rated power class F	kVA	6	6	6	5	5,5	7,2	7,2	7,2	
	kW	5	5	5	4	4,4	5,8	5,8	5,8	
Regulation with	DSR	±1 % with any power factor and speed variations between -5% +30%								
Insulation class		H								
Execution		Brushless								
Stator winding		12 ends								
Rotor		without damping cage								
Efficiencies class H	4/4	%	81,7	81,8	81,5	81,3	82,6	83,1	83,2	83,3
(see graph. for details)	3/4	%	82,1	82,4	82,3	82	83,3	83,5	83,7	83,9
	2/4	%	78,8	78,9	78,9	78,6	80,1	80,2	80,3	80,4
	1/4	%	75,1	75	74,8	74,3	76,2	76	76,1	76,4
Reactances (f. l.cl. F)	Xd	%	187,5	169,2	157,2	118,3	203,1	201,4	184,2	169,2
	Xd'	%	18,4	16,6	15,4	11,6	19,9	19,8	18,1	16,6
	Xd''	%	15,6	14,1	13,1	9,9	16,9	16,8	15,4	14,1
	Xq	%	65,8	59,4	55,2	41,5	71,3	70,7	64,7	59,4
	Xq'	%	65,8	59,4	55,2	41,5	71,3	70,7	64,7	59,4
	Xq''	%	75,5	68,1	63,3	47,6	81,8	81,0	74,2	68,1
	X ₂	%	17,2	15,5	14,4	10,8	18,6	18,4	16,9	15,5
	X ₀	%	6,8	6,1	5,7	4,3	7,3	7,3	6,6	6,1
Short Circuit Ratio	Kcc		0,86	1	1,19	1,50	0,73	0,81	0,86	1
Time Constants	Td'	sec.	0,026							
	Td''	sec.	0,025							
	Tdo'	sec.	0,71							
	Tα	sec.	0,011							
Short Circuit Current Capacity		%	>300				>320			
Excitation at no load	Amp.		0,28	0,36	0,41	0,48	0,18	0,2	0,22	0,25
Excitation at full load	Amp.		0,99	1,08	1,1	1,2	0,75	0,8	0,9	0,95
Overload (long-term)		%	1 hour in a 6 hours period 110% rated load							
Overload per 20 sec.		%	300							
Stator Winding Resistance (20°C)	Ω		0,969							
Rotor Winding Resistance (20°C)	Ω		6,078							
Exciter Resistance (20 °C)	Ω		Rotor : 1,453				Stator : 15,71			
Heat dissipation at f.l.cl.H	W		1165	1157	1180	1012	1180	1269	1260	1251
Telephone Interference			THF < 2%				TIF < 45			
Radio interference			EN61000-6-3, EN61000-6-2. For others standards apply to factory							
Waveform Distors.(THD) at f. load	LL/LN %		2,93 / 2,5							
Waveform Distors.(THD) at no load	LL/LN %		2,8 / 2,6							
Mechanical characteristics										
Protection			IP 23 (other protection on request)							
DE bearing			6308-2RS							
NDE bearing			6305-2RS							
Weight of wound stator assembly	kg		17,5							
Weight of wound rotor assembly	kg		12,5							
Weight of complete generator	kg		59							
Maximun overspeed	rpm		2250							
Unbalanced magnetic pull at f.l.cl.F	kN/mm		2,5							
Cooling air requirement	m³/min		3,5				3,9			
Inertia Constant (H)	sec.		0,100				0,120			
Noise level at 1m/7m	dB(A)		72 / 58				78 / 60			

All technical data are to be considered as a reference and they can be modified without any notice

This document is a propriety of Mecc Alte S.p.a..All rights reserved.



GENERATOR TYPE ECP 3-1S/4

Document : DS148A/2

issue 002 date : 29/04/2014

50 Hz

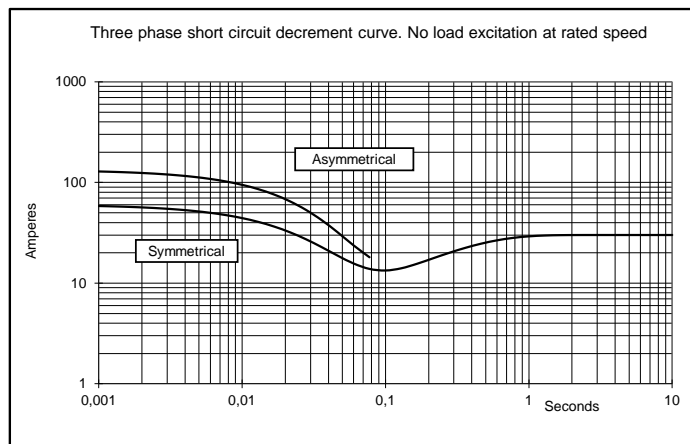
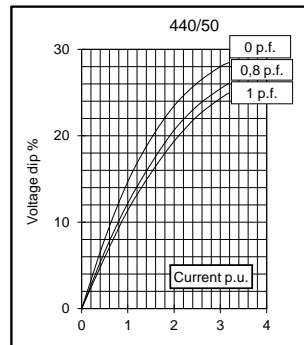
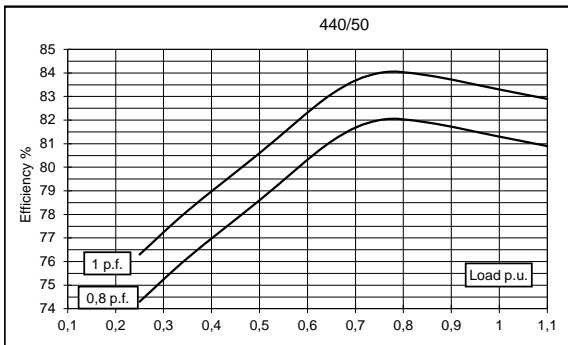
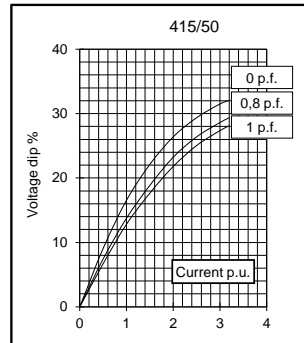
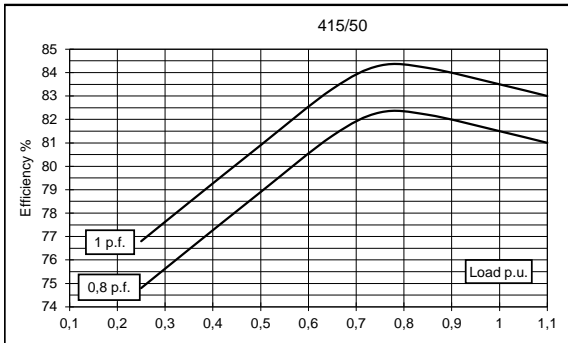
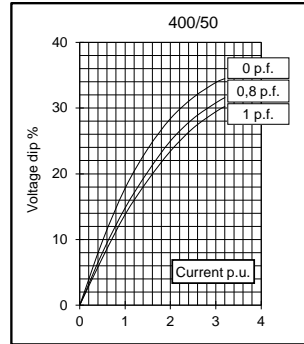
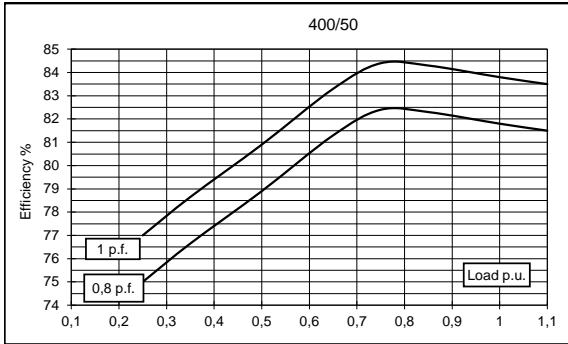
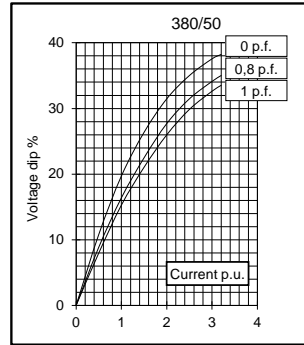
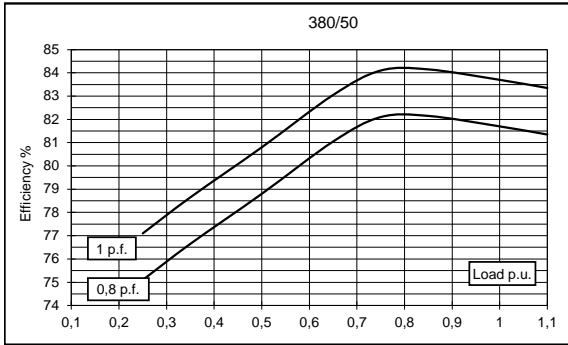

All technical data are to be considered as a reference and they can be modified without any notice
This document is a propriety of Mecc Alte S.p.a.. All rights reserved.



GENERATOR TYPE ECP 3-1S/4

Document : DS148A/3

issue 002 date : 29/04/2014

60 Hz

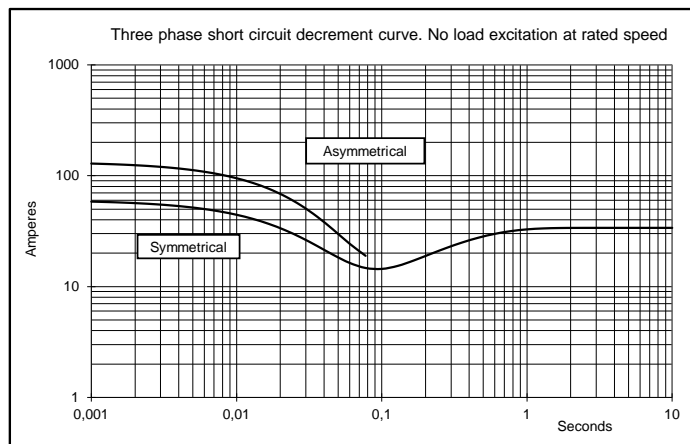
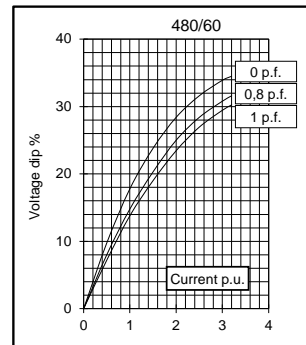
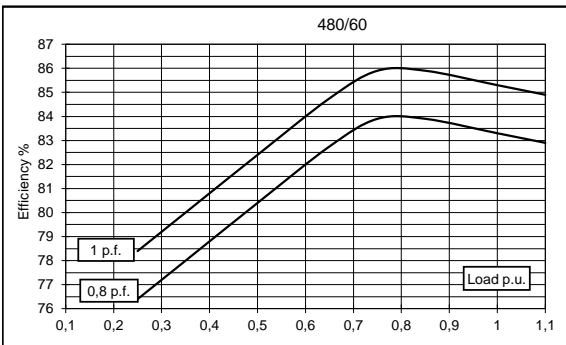
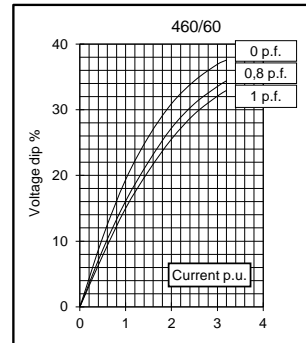
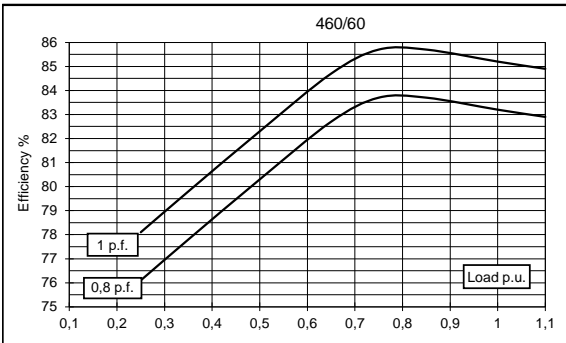
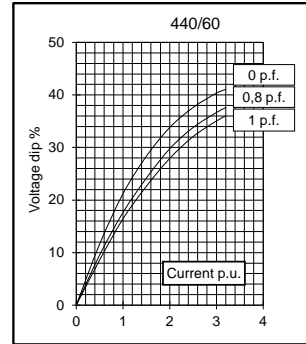
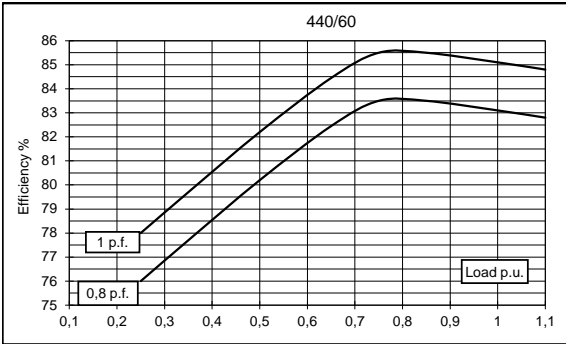
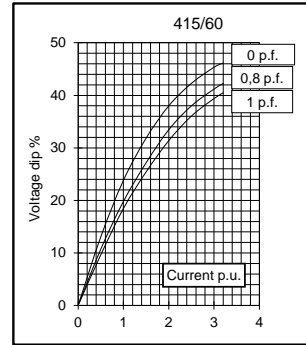
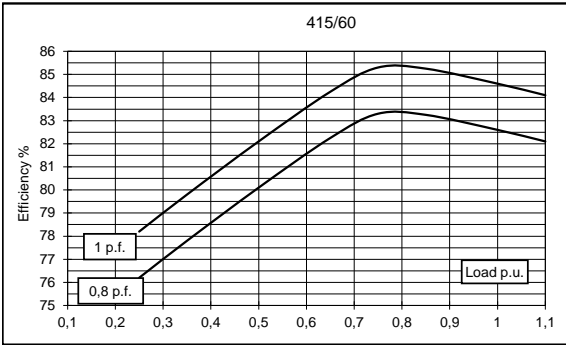

All technical data are to be considered as a reference and they can be modified without any notice
This document is a propriety of Mecc Alte S.p.a.. All rights reserved.

TWO BEARING MOMENTS OF INERTIA

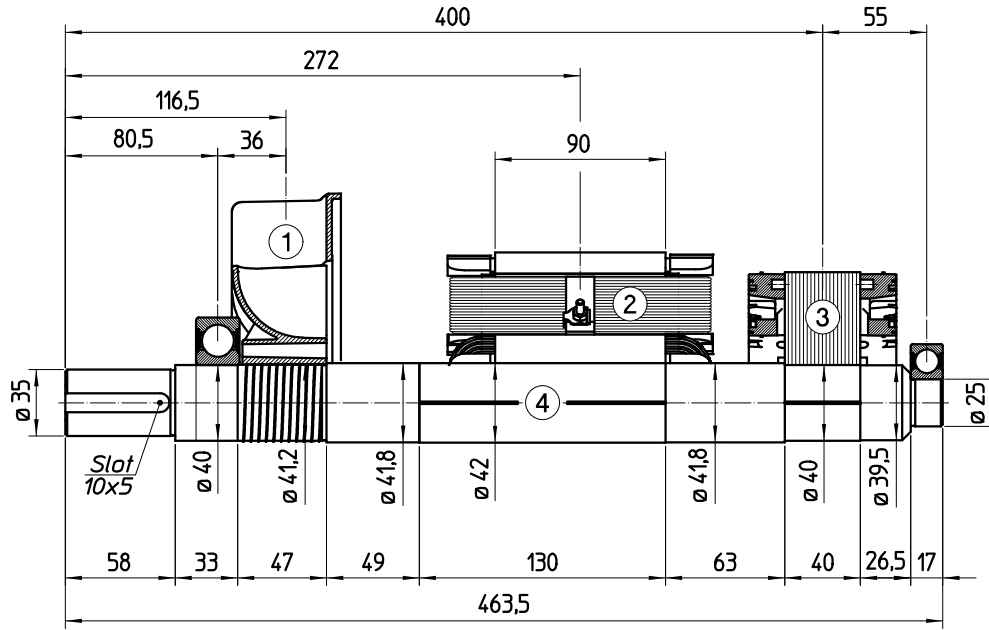

POS.	COMPONENT	WEIGHT (kg)	J (kgm ²)
1	FAN	0,4	0,00206
2	MAIN ROTOR	12,5	0,03846
3	EX. ROTOR	4,2	0,01086
4	SHAFT	4,5	0,00093
TOTAL		21,6	0,05231

TWO BEARING DIMENSIONS

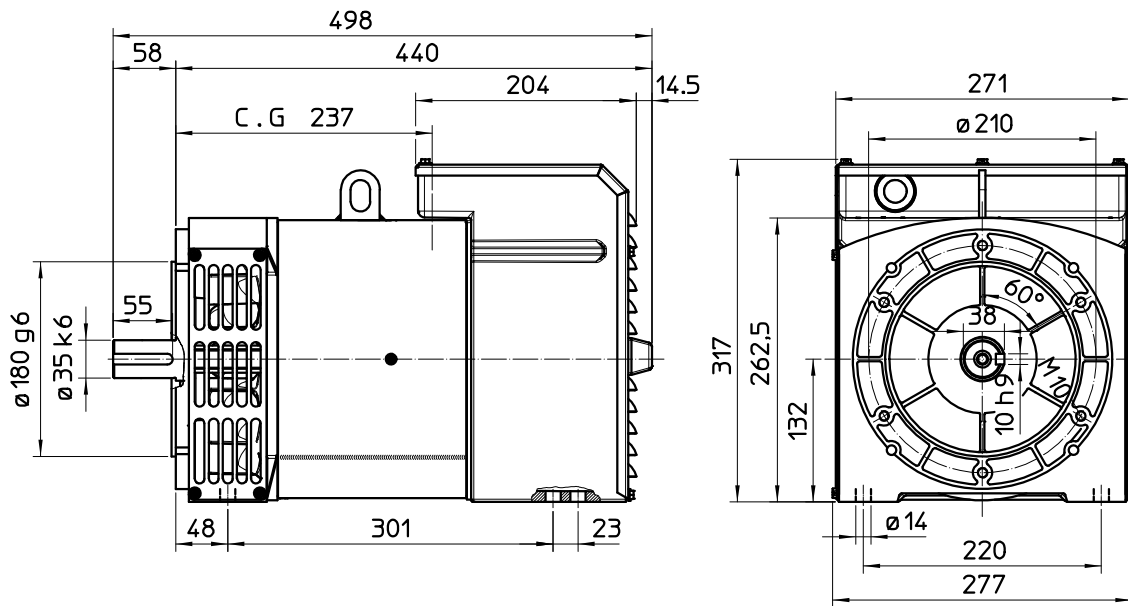

SINGLE BEARING MOMENTS OF INERTIA

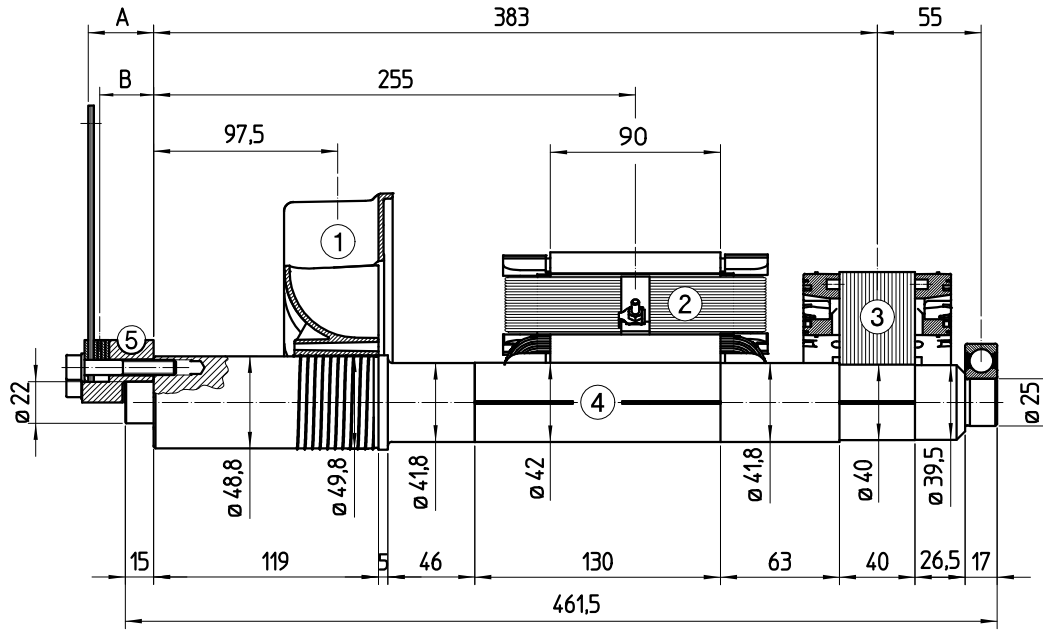

POS.	COMPONENT	WEIGHT (kg)	J (kgm ²)
1	FAN	0,4	0,00206
2	MAIN ROTOR	12,5	0,03846
3	EX. ROTOR	4,2	0,01086
4	SHAFT	5,1	0,00123
TOTAL		22,2	0,05261

SAE N°	SHAFTS COUPLING FLEX PLATE			
	A	B	WEIGHT kg	J kgm ²
5				
6 1/2	3	1,5	1,00	0,00495
7 1/2	3	1,5	1,20	0,00769
8	34,6	29,5	1,75	0,01114
10	26,6	23,5	2,14	0,02220
11 1/2	13	11	2,60	0,03524

SINGLE BEARING DIMENSIONS

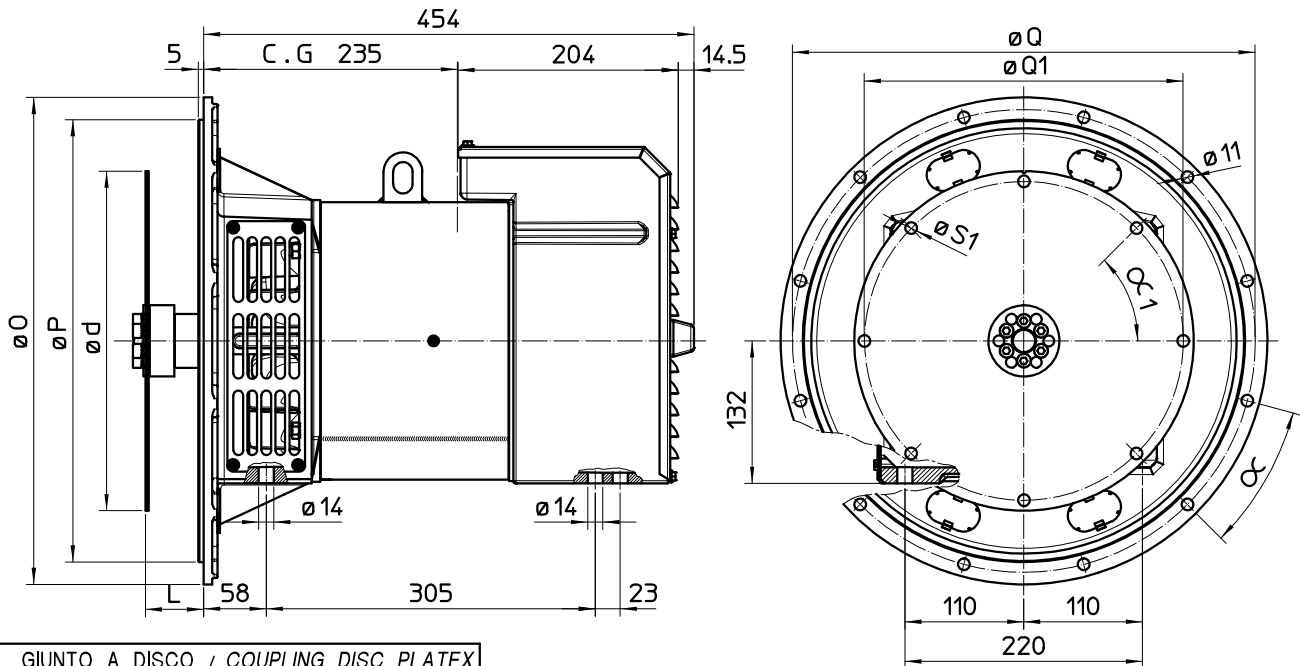

GIUNTO A DISCO / COUPLING DISC PLATEX						
SAE	L	d	Q1	Fori N° Holes N°	S1	α ₁
6 ‡	30,2	215,9	200	6	9	60°
7 ‡	30,2	241,3	222,25	8	9	45°
8	62	263,52	244,47	6	11	60°
10	53,8	314,52	295,27	8	11	45°
11 ‡	39,6	352,42	333,37	8	11	45°

FLANGIE / FLANGE					
SAE	O	P	Q	Fori N° Holes N°	α
6	308	266,7	285,75	8	22°30'
5	356	314,3	333,4	8	22°30'
4	403	362	381	12	15°
3	451	409,6	428,6	12	15°

C.G.= GRAVITY CENTER